



Thank you for choosing Philips.

Need help fast?

Read your Quick Use Guide and/or Owner's Manual first for quick tips that make using your Philips product more enjoyable.

If you have read your instructions and still need assistance, you may access our online help at

www.philips.com/usasupport
while with your product.
(and Model / Serial number)



Philips vous remercie de votre confiance.

Besoin d'une aide rapide?

Les Guide d'utilisation rapide et Manuel de l'utilisateur regorgent d'astuces destinées à simplifier l'utilisation de votre produit Philips. Toutefois, si vous ne parvenez pas à résoudre votre problème, vous pouvez accéder à notre aide en ligne à l'adresse

www.philips.com/usasupport
Veillez à avoir votre produit à portée de main.
(et model / serial nombre)



Gracias por escoger Philips

Necesita ayuda inmediata?

Lea primero la Guía de uso rápido o el Manual del usuario, en donde encontrará consejos que le ayudarán a disfrutar plenamente de su producto Philips.

Si después de leerlo aún necesita ayuda, consulte nuestro servicio de asistencia en línea en

www.philips.com/usasupport
y tenga a mano el producto.
(y número de model / serial)



PHILIPS

Canada

English:

This digital apparatus does not exceed the Class B limits for radio noise emissions from digital apparatus as set out in the Radio Interference Regulations of the Canadian Department of Communications.

Français:

Cet appareil numérique n'émet pas de bruits radioélectriques dépassant les limites applicables aux appareils numériques de Class B prescrites dans le Règlement sur le Brouillage Radioélectrique édicté par le Ministère des Communications du Canada.

CAUTION

Use of controls or adjustments or performance of procedures other than herein may result in hazardous radiation exposure or other unsafe operation.

ATTENTION

L'utilisation des commandes ou réglages ou le non-respect des procédures ci-incluses peuvent se traduire par une exposition dangereuse à l'irradiation.

ATENCIÓN

El uso de mando o ajustes o la ejecución de métodos que no sean los aquí descritos puede ocasionar peligro de exposición a radiación.

DEMO MODE

To turn ON

Press

STOP ■

button

To turn OFF

Press

STOP ■

button again

**Return your Product Registration Card or register online at
www.philips.com/usasupport today to get the very most from your purchase.**

Registering your model with PHILIPS makes you eligible for all of the valuable benefits listed below, so don't miss out. Complete and return your Product Registration Card at once, or register online at www.philips.com/usasupport to ensure:

***Proof of Purchase**

Returning the enclosed card guarantees that your date of purchase will be on file, so no additional paperwork will be required from you to obtain warranty service.

***Product Safety Notification**

By registering your product, you'll receive notification - directly from the manufacturer - in the rare case of a product recall or safety defect.

***Additional Benefits**

Registering your product guarantees that you'll receive all of the privileges to which you're entitled, including special money-saving offers.

PHILIPS

Congratulations on your purchase, and welcome to the "family!"

Dear PHILIPS product owner:

Thank you for your confidence in PHILIPS. You've selected one of the best-built, best-backed products available today. We'll do everything in our power to keep you happy with your purchase for many years to come.

As a member of the PHILIPS "family," you're entitled to protection by one of the most comprehensive warranties and outstanding service networks in the industry. What's more, your purchase guarantees you'll receive all the information and special offers for which you qualify, plus easy access to accessories from our convenient home shopping network.

Most importantly, you can count on our uncompromising commitment to your total satisfaction.

All of this is our way of saying welcome - and thanks for investing in a PHILIPS product.

P.S. To get the most from your PHILIPS purchase, be sure to complete and return your Product Registration Card at once, or register online at:

www.philips.com/usasupport

Know these **safety** symbols



⚡ This "bolt of lightning" indicates uninsulated material within your unit may cause an electrical shock. For the safety of everyone in your household, please do not remove product covering.

⚠ The "exclamation point" calls attention to features for which you should read the enclosed literature closely to prevent operating and maintenance problems.

WARNING: To reduce the risk of fire or electric shock, this apparatus should not be exposed to rain or moisture and objects filled with liquids, such as vases, should not be placed on this apparatus.

CAUTION: To prevent electric shock, match wide blade of plug to wide slot, fully insert.

ATTENTION: Pour éviter les choc électriques, introduire la lame la plus large de la fiche dans la borne correspondante de la prise et pousser jusqu'au fond.

For Customer Use

Enter below the Serial No. which is located on the rear of the cabinet. Retain this information for future reference.

Model No. _____
Serial No. _____

PHILIPS

Visit our World Wide Web Site at <http://www.philips.com/usasupport>

IMPORTANT SAFETY INSTRUCTIONS

1. **Read these instructions.**
2. **Keep these instructions.**
3. **Heed all warnings.**
4. **Follow all instructions.**
5. **Do not use this apparatus near water.**
6. **Clean only with dry cloth.**
7. **Do not block any ventilation openings. Install in accordance with the manufacturer's instructions.**
8. **Do not install near any heat sources** such as radiators, heat registers, stoves, or other apparatus (including amplifiers) that produce heat.

9. **Do not defeat the safety**

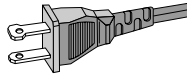

AC Polarized Plug

purpose of the polarized or grounding-type plug. A polarized plug has two blades with one wider than the other. A grounding type plug has two blades and a third grounding prong. The wide blade or the third prong are provided for your safety. If the provided plug does not fit into your outlet, consult an electrician for replacement of the obsolete outlet.

10. **Protect the power cord** from being walked on or pinched, particularly at plugs, convenience receptacles, and the point where they exit from the apparatus.
11. **Only use attachments/accessories** specified by the manufacturer:

12.  **Use only with the cart,** stand, tripod, bracket, or table specified by the manufacturer or sold with the apparatus. When a cart is used, use caution when moving the cart /apparatus combination to avoid injury from tip-over.

13. **Unplug this apparatus** during lightning storms or when unused for long periods of time.
14. **Refer all servicing** to qualified service personnel. Servicing is required when the apparatus has been damaged in any way, such as power-supply cord or plug is damaged, liquid has been spilled or objects have fallen into the apparatus, the apparatus has been exposed to rain or moisture, does not operate normally, or has been dropped.

15. **Battery usage CAUTION** – To prevent battery leakage which may result in bodily injury, property damage, or damage to the unit:

Install **all** batteries correctly, **+** and **-** as marked on the unit.

Do not mix batteries (**old** and **new** or **carbon** and **alkaline**, etc.).

Remove batteries when the unit is not used for a long time.

16. **Apparatus shall not be exposed to dripping or splashing.**
17. **Do not place any sources of danger on the apparatus** (e.g. liquid filled objects, lighted candles).
18. This product may contain lead and mercury. Disposal of these materials may be regulated due to environment considerations.
For disposal or recycling information, please contact your local authorities or the Electronic Industries Alliance: www.eiae.org.

EL 6475-S004: 03/12

Class II equipment symbol 
This symbol indicates that the unit has a double insulation system

English	7
Français	47
Español	87

This product incorporates copyright protection technology that is protected by method claims of certain U.S. patents and other intellectual property rights owned by Macrovision Corporation and other rights owners. Use of this copyright protection technology must be authorized by Macrovision Corporation, and is intended for home and other limited viewing uses only unless otherwise authorized by Macrovision Corporation. Reverse engineering or disassembly is prohibited.

DivX, DivX Certified, and associated logos are trademarks of DivX Networks, Inc and are used under license.



Windows Media is a trademark of Microsoft Corporation.

Manufactured under license from Dolby Laboratories.

"Dolby", "Pro Logic" and the double-D symbol are trademarks of Dolby Laboratories.

HDMI

HDMI (High Definition Multimedia Interface) is a digital interface that allows pure HD digital video transmission without the loss of image quality. The integrated control bus allows system control between the TV set and connected devices like a digital set top box.

Language Code

Abkhazian	6566
Afar	6565
Afrikaans	6570
Amharic	6577
Arabic	6582
Armenian	7289
Assamese	6583
Avestan	6569
Aymara	6589
Azerbaijani	6590
Bahasa Melayu	7783
Bashkir	6665
Belarusian	6669
Bengali	6678
Bihari	6672
Bislama	6673
Bokmål, Norwegian	7866
Bosanski	6683
Brezhoneg	6682
Bulgarian	6671
Burmese	7789
Castellano, Español	6983
Catalán	6765
Chamorro	6772
Chechen	6769
Chewa; Chichewa; Nyanja	7889
中文	9072
Chuang; Zhuang	9065
Church Slav; Slavonic	6785
Chuvash	6786
Corsican	6779
Česky	6783
Dansk	6865
Deutsch	6869
Dzongkha	6890
English	6978
Esperanto	6979
Estonian	6984
Euskara	6985
Ελληνικά	6976
Faroese	7079
Français	7082
Frysk	7089
Fijian	7074
Gaelic; Scottish Gaelic	7168
Gallegan	7176
Georgian	7565
Gikuyu; Kikuyu	7573
Guarani	7178
Gujarati	7185
Hausa	7265
Herero	7290
Hindi	7273
Hiri Motu	7279
Hrvatski	6779
Ido	7379
Interlingua (International)	7365
Interlingue	7365
Inuktitut	7385

Inupiaq	7375
Irish	7165
Íslenska	7383
Italiano	7384
Ivrit	7269
Japanese	7465
Javanese	7486
Kalaallisut	7576
Kannada	7578
Kashmiri	7583
Kazakh	7575
Kernewek	7587
Khmer	7577
Kinyarwanda	8287
Kirghiz	7589
Komi	7586
Korean	7579
Kuanyama; Kwanyama	7574
Kurdish	7585
Lao	7679
Latina	7665
Latvian	7686
Letzeburgesch;	7666
Limburgan; Limburger	7673
Lingala	7678
Lithuanian	7684
Luxembourgish;	7666
Macedonian	7775
Malagasy	7771
Magyar	7285
Malayalam	7776
Maltese	7784
Manx	7186
Maori	7773
Marathi	7782
Marshallese	7772
Moldavian	7779
Mongolian	7778
Nauru	7865
Navaho; Navajo	7886
Ndebele, North	7868
Ndebele, South	7882
Ndonga	7871
Nederlands	7876
Nepali	7869
Norsk	7879
Northern Sami	8369
North Ndebele	7868
Norwegian Nynorsk;	7878
Occitan; Provençal	7967
Old Bulgarian; Old Slavonic	6785
Oriya	7982
Oromo	7977
Ossetian; Ossetic	7983
Pali	8073
Panjabi	8065
Persian	7065
Polski	8076
Português	8084

Pushto	8083
Russian	8285
Quechua	8185
Raeto-Romance	8277
Romanian	8279
Rundi	8278
Samoan	8377
Sango	8371
Sanskrit	8365
Sardinian	8367
Serbian	8382
Shona	8378
Shqip	8381
Sindhi	8368
Sinhalese	8373
Slovensky	8373
Slovenian	8376
Somali	8379
Sotho; Southern	8384
South Ndebele	7882
Sundanese	8385
Suomi	7073
Swahili	8387
Swati	8383
Svenska	8386
Tagalog	8476
Tahitian	8489
Tajik	8471
Tamil	8465
Tatar	8484
Telugu	8469
Thai	8472
Tibetan	6679
Tigrinya	8473
Tonga (Tonga Islands)	8479
Tsonga	8483
Tswana	8478
Türkçe	8482
Turkmen	8475
Twi	8487
Uighur	8571
Ukrainian	8575
Urdu	8582
Uzbek	8590
Vietnamese	8673
Volapuk	8679
Walloon	8765
Welsh	6789
Wolof	8779
Xhosa	8872
Yiddish	8973
Yoruba	8979
Zulu	9085

General Information

Features	9
Supplied accessories	9
Environment information	9
Installation	9~10
Maintenance	10

Connections

Step 1: Placing the speakers	11
Step 2: Connecting speakers	12
Step 3: Connecting the control cable	12
Step 4: Connecting TV	12~14
Step 5: Connecting FM/AM antennas	14
Step 6: Connecting the power cord	15
Additional: Connecting additional equipment	15~16

Functional Overview

DVD player and power amplifier	17
Remote control	18~19

Getting Started

Step 1: Inserting batteries into the Remote Control	20
Using the Remote Control to operate the Player	
Step 2: Setting up the TV	20~21
Selecting the colour system that corresponds to your TV	
Setting up Progressive Scan feature	
To deactivate Progressive manually	
Step 3: Setting language preference	22
Setting the OSD Language	
Setting the Audio, Subtitle and Disc Menu language	

Basic Functions

Switching the system on/off	23
Switching the system to Eco Power Standby mode	23
Power-saving automatic standby	23
Volume control	23
Sound control	23
Bass enhancement	
Treble adjustment	
LOUDNESS	
Dimming the display screen	23
Demonstration mode	24

Disc Operations

Playable Discs	25
Playing discs	25
Using the Disc Menu	26
Basic playback controls	26~28
Pausing playback	
Selecting a track/chapter/title	
Resuming playback from the last stopped point	
Zoom	
Repeat	
Repeat A-B	
Slow Motion	
Program	
Forward/Reverse Searching	
Time search & search by chapter/track number	
Information display during playback	
Special disc features	28
Playing a Title	
Camera Angle	
Changing the Audio Language	
Changing the Audio Channel	
Playing MP3/WMA/JPEG Picture disc	28
Playing MP3/WMA disc	28
General operation	
Playback selection	
Playing JPEG Picture CD	29
General operation	
Playback selection	
Special JPEG features	29
Preview function	
Zoom picture	
Playback with multi-angles	
Playing a DivX disc	30

System Menu Options

Basic Operations	31
GENERAL SETUP PAGE	31~32
TV DISPLAY	
OSD LANGUAGE	
CLOSED CAPTIONS	
SCREEN SAVER	
DIVX CODE	
AUDIO SETUP PAGE	32~33
SPDIF SETUP	
DOLBY DIGITAL SETUP	
3D PROCESSING	
HDCD	
NIGHT MODE	
VIDEO SETUP PAGE	33~35
COMPONENT	
TV MODE	
QUALITY	
HDMI SETUP	
PREFERENCE PAGE	35~36
PARENTAL	
DEFAULT	
PASSWORD SETUP PAGE	36
PASSWORD MODE	
PASSWORD	

Other Functions

Radio reception	37
Tuning to radio stations	
Presetting radio stations	
Listening to preset radio stations	
Setting the clock	38
Setting sleep/wake-up timer	38
Sleep timer setting	
Wake-up timer setting	

Specifications

39

Troubleshooting

40~42

Glossary

43

Features

Your DVD Micro Theatre with 2.0 channel full digital amplifier creates the same dynamic sound qualities that you find in full-fledged cinemas and incorporates some of the best features in home theater technology.

Other features include:

Built-in Dolby Digital decoder, supporting DSC sound setting.

Additional Component Connections

Lets you connect other audio and audio/visual components to the DVD micro theatre.

Night mode

Lets you compress the dynamic range, reducing the difference in loudness between different sounds in Dolby Digital mode.

Parental Control (Rating Level)

Lets you set a ratings level so that your children cannot watch a DVD that has a rating higher than you set.

Sleep/Wake-up Timer

Enables the system to switch on/off automatically at a preset time.

Progressive Scan

Provides high quality flicker-free images for film based sources. When a picture refreshes, its vertical resolution can double to 525 lines.

Note:

– *To fully enjoy the progressive scan feature, you need a progressive scan TV.*

Hi-Fi Tube Sound from DVD Micro Theatre

Why do I need it?

You deserve an immersive sound experience like an audiophile.

The built-in vacuum tube preamplifier enables you to experience the highest quality sound normally you can only find in premium Hi-Fi audio equipment.

Music is dynamic and is played to be heard by human ears. The analogue nature of tube gives a more pleasing sound to the nonlinear human ear-brain hearing system. Tube sound has less distortion than solid-state sound and audiophiles always prefer tubes for their clean, warm and far more detailed and life-like sound.

What is it?

Vacuum tube is not something new, but always a premium.

Before the introduction of transistors, most electronic amplifier used vacuum tubes. By 60s', solid-state amplification became more common, but tube amplifier has retained a loyal following among audiophiles with modern units from companies commanding very high price.

How does it work?

Amplifiers are available based on solid-state (semiconductor) technology or vacuum-tube (valve) technology. Many audiophile systems separate the functions of the preamplifier-which selects audio signals and has a volume control- and the power amplifier; which takes a line-level audio signal and drives the loudspeakers. Audiophiles find the tube preamplifier product a more faithful and detailed reproduction in comparison to the solid-state preamplifier.

General Information

Supplied accessories

- Remote control with two AAA batteries
- AM loop antenna
- FM wire antenna
- Audio (white, red) and composite video (yellow) cables (2-in-1)
- Control cable
- 2 front speakers including 2 speaker cables
- This instruction booklet and a Quick Start Guide

If any item is damaged or missing, contact your retailer or Philips.

Environmental information

All unnecessary packaging has been omitted. We have tried to make the packaging easy to separate into three materials: cardboard (box), polystyrene foam (buffer) and polyethylene (bags, protective foam sheet).

Your system consists of materials which can be recycled and reused if disassembled by a specialised company. Please observe the local regulations regarding the disposal of packaging materials, exhausted batteries and old equipment.

Installation

- Place the player on a flat, hard, and stable surface.
- In a cabinet, allow about 10cm (4 inches) of free space all around the player for adequate ventilation.

- Do not expose your player to extreme temperatures or humidity.
- The apparatus shall not be exposed to dripping or splashing.
- No objects filled with liquids, such as vases, shall be placed on the apparatus.
- No naked flame sources, such as lighted candles, shall be placed on the apparatus.
- Install this unit near the AC outlet and where the AC power plug can be reached easily.
- The ventilation should not be impeded by covering the ventilation openings with items, such as newspapers, table-cloths, curtains, et.

Maintenance

- When a disc becomes dirty, clean it with a cleaning cloth. Wipe the disc from the center out, in a straight line.
- Do not expose the player, batteries or discs to humidity, rain, sand or excessive heat (caused by heating equipment or direct sunlight). Always keep the disc tray closed to avoid dust on the lens.
- Do not use solvents such as benzene, thinner, commercially available cleaners, or anti-static spray intended for colour discs.
- The lens may cloud over when the player is suddenly moved from cold to warm surroundings, making it impossible to play a disc. Leave the player in the warm environment until the moisture evaporates.



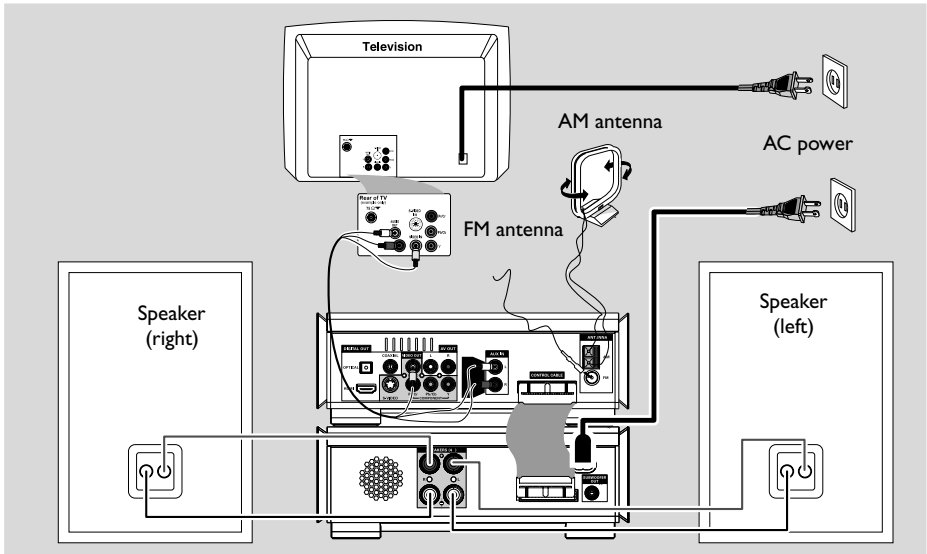

IMPORTANT!

- The type plate is located at the bottom of the system.
- Before connecting the AC power cord to the wall outlet, ensure that all other connections have been made.
- Never make or change any connections with the power switched on.

Step 1: Placing the speakers

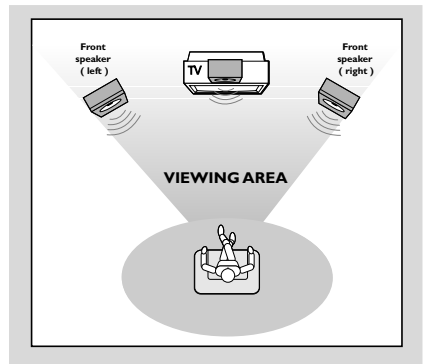

- Place the front left and right speakers at equal distances from the TV set and at an angle of approximately 45 degrees from the listening position.

Notes:

- To avoid magnetic interference, do not position the front speakers too close to your TV set.
- Allow adequate ventilation around the DVD System.

Step 2: Connecting speakers

- Connect the left and right speakers to the SPEAKERS (4Ω) terminals on the back of the power amplifier with the supplied speaker cables. Right speaker to "R" and left speaker to "L", red wire to "+" and black wire to "-". Fully insert the stripped portion of the speaker wire into the terminal as shown.

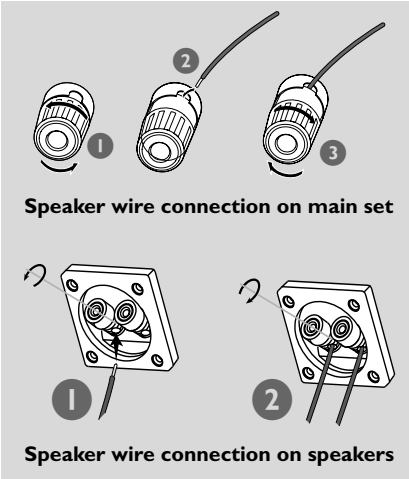

Notes:

- Ensure that the speaker cables are correctly connected. Improper connections may damage the system due to short-circuit.
- For optimal sound performance, use the supplied speakers.
- Do not connect more than one speaker to any one pair of +/- speaker jacks.
- Do not connect speakers with an impedance lower than the speakers supplied. Please refer to the SPECIFICATIONS section of this manual.

Step 3: Connecting the control cable

- Connect the serial port marked "CONTROL CABLE" at the rear of the DVD player to the same port at the rear of the power amplifier with the supplied flat control cable.

Step 4: Connecting TV

IMPORTANT!

- You only need to make one video connection from the following options, depending on the capabilities of your TV.
- Connect the DVD system directly to the TV.

Using Composite Video jack

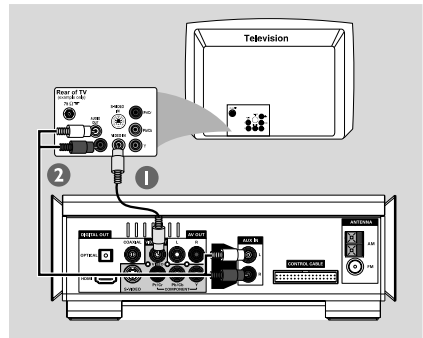

- 1 Use the composite video connectors (yellow) of the supplied audio and composite video cables (2-in1) to connect the DVD system's **VIDEO OUT** jack to the video input jack (or labeled as A/V In, CVBS, Composite or Baseband) on the TV.
- 2 To hear the TV channels through this DVD system, use the audio connectors (white/ red) of the supplied audio and composite video cables (2-in1) to connect **AUX IN L/R** jacks to the corresponding AUDIO OUT jacks on the TV.

Using Component Video jacks (Y Pb Pr)

IMPORTANT!

– The progressive scan video quality is only possible when using Y Pb Pr, and a progressive scan TV is required.

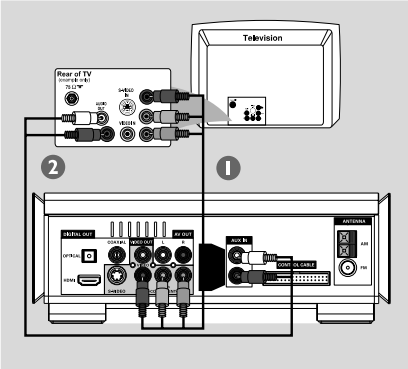

- 1 Use component video cables (red/blue/green - not supplied) to connect the DVD system's **COMPONENT (Pr/Cr Pb/Cb Y)** jacks to the corresponding Component video input jacks (or labeled as Y Pb/Cb Pr/Cr or YUV) on the TV.
- 2 To hear the TV channels through this DVD system, use the audio connectors (white/ red) of the supplied audio and composite video cables (2-in1) to connect **AUX IN L/R** jacks to the corresponding AUDIO OUT jacks on the TV.
- 3 If you are using a Progressive Scan TV (TV must indicate Progressive Scan or ProScan capability), to activate TV Progressive Scan, please refer to your TV user manual. For DVD system Progressive Scan function, see "Getting Started-Setting up Progressive Scan feature".

Note:

– If your TV does not support Progressive Scan, you will not be able to view the picture. Press **SYSTEM** on the remote to exit the system menu and then **DISC** and "1" to exit progressive scan.

Using S-Video jack

IMPORTANT!

– If S-Video is used for DVD playback connection, the system's VIDEO OUT setting will need to be changed accordingly.

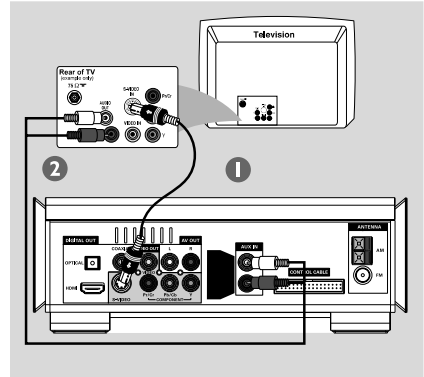

- 1 Use an S-Video cable (not supplied) to connect the DVD system's **S-VIDEO** jack to the S-Video input jack (or labeled as Y/C or S-VHS) on the TV.
- 2 To hear the TV channels through this DVD system, use the audio connectors (white/ red) of the supplied audio and composite video cables (2-in1) to connect **AUX IN L/R** jacks to the corresponding AUDIO OUT jacks on the TV.

Using an accessory RF modulator

IMPORTANT!

– If your TV only has a single Antenna In jack (labeled as 75 ohm or RF In), you will need an RF modulator in order to view DVD playback on the TV. See your electronics retailer or contact Philips for details on RF modulator availability and operations.

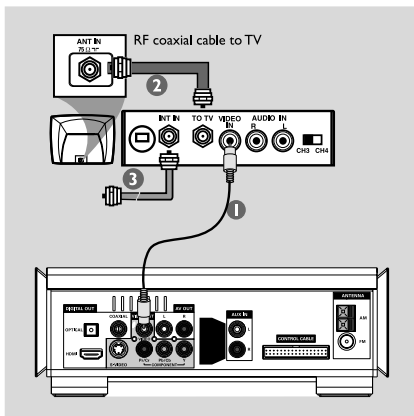

- 1 Use the composite video cable (yellow) to connect the DVD system's **VIDEO** jack to the video input jack on the RF modulator.
- 2 Use an RF coaxial cable (not supplied) to connect ANTENNA OUT or TO TV jack on the RF modulator to the Antenna IN jack on the TV.
- 3 Connect the Antenna or Cable TV service signal to the ANTENNA IN or RF IN jack on the RF modulator: (It may have been connected to your TV previously. Disconnect it from the TV.)

Step 5: Connecting FM/AM antennas

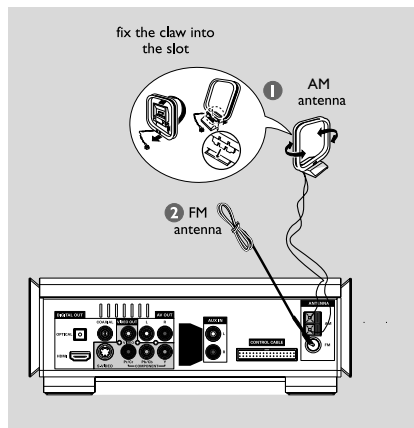

- 1 Connect the supplied AM loop antenna to the AM jack. Place the AM loop antenna on a shelf or attach to a stand or wall.
- 2 Connect the supplied FM antenna to the FM (75 Ω) jack. Extend the FM antenna and fix its end to the wall.

For better FM stereo reception, connect an external FM antenna (not supplied).

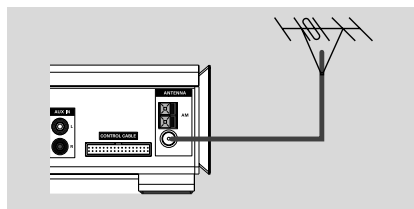

Note:

- Adjust the position of the antennas for optimal reception.
- Position the antennas as far as possible from your TV, VCR or other radiation source to prevent unwanted interference.

Step 6: Connecting the power cord

After everything is connected properly, plug in the AC power cord to the power outlet.

Never make or change any connection with the power switched on.

Additional: Connecting additional equipment

IMPORTANT!

- Some discs are copy-protected. You cannot record the disc through a VCR or digital recording device.
- When making connections, make sure the colour of cables matches the colour of jacks.
- Always refer to the owner's manual of the other equipment for complete connection and usage details.

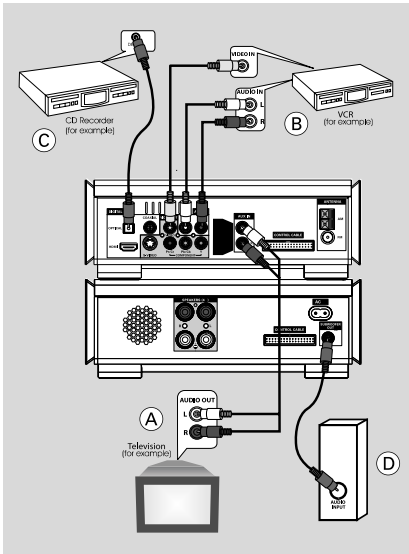

Viewing and listening to the playback of other equipment (A)

- Connect the system's **AUX IN L/R** jacks to the **AUDIO OUT** jacks on the other audio/visual device (such as a TV, VCR, Laser Disc player or cassette deck).
Before starting operation, press **SOURCE** on the front panel to select **AUX** or press **AUX** on the remote in order to activate the input source.

Using the VCR for recording DVDs (B)

- Connect one of the system's **VIDEO** jack to the corresponding **VIDEO IN** jack and **AUDIO OUT L/R** jacks to the **AUDIO IN** jacks on the VCR. This will allow you to make analogue stereo (two channel, right and left) recordings.

Recording (digital) (C)

- Connect the system's **COAXIAL** or **OPTICAL** jack to the **DIGITAL IN** jack on a digital recording device.
Before starting operation, set the **DIGITAL OUT** according to the audio connection. (See "DIGITAL OUT".)

Connecting an active subwoofer (D)

- Connect the DVD micro system's **SUBWOOFER OUT** jack to the **AUDIO INPUT** jack on an active subwoofer (not supplied).

Connecting to a TV with HDMI Jack ^E

HDMI connects untouched and uncompressed digital transmission for the highest and crispest sound/image quality.

It has plug and play capability using only one cable for both audio/video output.

- Use a HDMI cable (not supplied) to connect the **HDMI** jack on the DVD Player to **HDMI IN** on a HDMI compatible device (e.g.;TV, Projector, Adaptor).
 - It may take a while for the DVD player and input device to communicate and initialise.
 - Playback starts automatically.

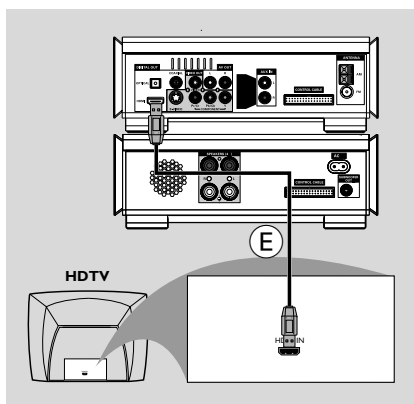

Notes:

- Proceed to "Setup Menu Options" → "VIDEO SETUP PAGE" → "HDMI SETUP" for detailed HDMI setup.
- If you are using the HDMI as audio source make sure that "DIGITAL OUTPUT" is set to "PCM only" (see "Setup Menu Options" → "AUDIO SETUP PAGE" → "DIGITAL AUDIO SETUP").
- To stop sound output from your TV after making the HDMI connection, make sure that "DIGITAL OUTPUT" is set to "SPDIF OFF" (see "Setup Menu Options" → "AUDIO SETUP PAGE" → "DIGITAL AUDIO SETUP").

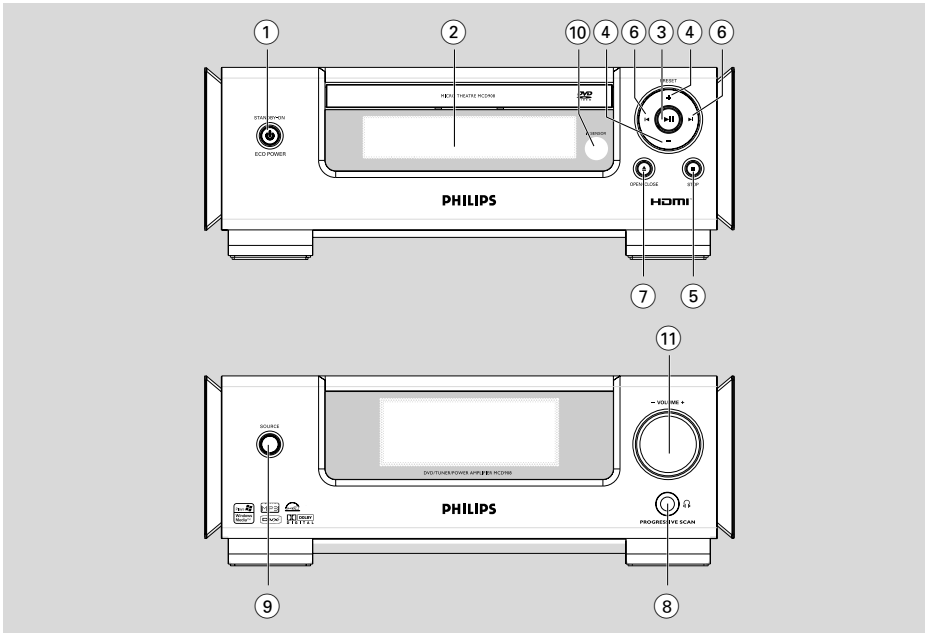

DVD player and power amplifier

- ① **ECO POWER/STANDBY-ON**

 - switches on the system or puts it on to Eco power/normal standby mode.

- ② **Display**

 - shows the current status of the DVD player.

- ③ **▶ II**

 - starts or interrupts disc playback.

- ④ **PRESET +/-**

 - in tuner mode, selects a preset radio station.

- ⑤ **STOP ■**

 - stops disc playback or erases a program.
 - in Demo mode (*on the system only*), activates/deactivates the demonstration.

- ⑥ **◀▶**

 - Disc:**

 - skips to the previous/next chapter/title/track.

 - Tuner:**

 - tunes to a higher/lower radio frequency.

- press and hold, then release the key to start automatic search for a radio frequency downward/upward.
- ⑦ **OPEN•CLOSE**

 - opens or closes the disc tray.

- ⑧

 - connect a headphone.

- ⑨ **SOURCE**

 - selects the respective sound source: DVD/AUX/TUNER (FM/AM).
 - switches the system on.

- ⑩ **IR SENSOR**

 - point the remote control towards this sensor:

- ⑪ **VOLUME +/-**

 - adjusts the volume upward/downward.
 - adjusts the hours and minutes in clock/timer setting mode.
 - switches the set timer ON or OFF.

Functional Overview

Remote control

- ① **⏻**
 - switches on the system or puts it on to Eco power/normal standby mode.
- ② **▲**
 - opens or closes the disc compartment
- ③ **Numeric Keypad (0-9)**
 - inputs a track/title/chapter number of the disc.

- ④ **PROG**
 - DVD/VCD/CD: enters the program menu.
 - MP3/WMA-CD: adds/deletes a programmed track to/from the program list.
 - Tuner: programs preset radio stations.
- ⑤ **GOTO**
 - Disc: fast searches in a disc by entering a time, title, chapter or track.
- ⑥ **SYSTEM (disc mode only)**
 - enters or exits the system menu.
- ⑦ **DISC MENU (disc mode only)**
 - DVD/VCD: enters or exits the disc contents menu.
 - VCD2.0: switches the playback control mode on or off.
 - MP3/WMA: switches between Album and Filelist.
- ⑧ **▼ / ▲ / ► / ◀**
 - selects an item in a menu.
 - moves an enlarged picture up/down/left/right.
- ⑨ **OK**
 - confirms a selection.
- ⑩ **ZOOM**
 - DVD/VCD/Picture CD: enlarges or reduces a picture or active image on the TV screen.
- ⑪ **MUTE**
 - disables or enables sound output.
- ⑫ **◀◀ / ▶▶**
 - Tuner**
 - press to tune to a lower/higher radio frequency gradually.
 - press and hold, then release the key to start automatic search for a radio frequency downward/upward.
 - Disc**
 - searches backward/forward in a disc at different speeds.

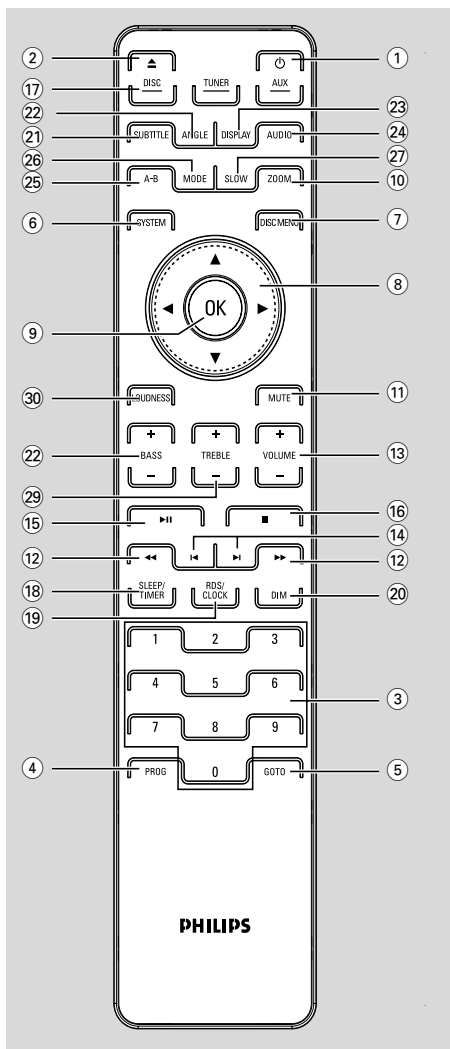

13 VOLUME +/-

- adjusts the volume upward/downward.
- adjusts the hours and minutes in clock/timer setting mode.
- switches the set timer ON or OFF.

14 ◀ / ▶

- Disc: skips to the previous/next chapter/title/ track
- Tuner: selects a preset radio station.

15 ▶ ||

- starts or interrupts disc playback.

16 ■

- stops disc playback or erases a program.

17 DISC/TUNER/AUX

- selects the respective sound source for DVD/ AUX/TUNER (FM/AM).
- For tuner (TUNER): press to switch between AM and FM
- exits P-SCAN (progressive scan). (Only for DISC)

18 SLEEP/TIMER

Standby mode

- sets time for switching on the system automatically.

Power-on mode

- sets the sleep timer function (auto off).

19 RDS/CLOCK (RDS function unavailable for this version)

Standby mode

- sets the system clock.

Playback mode

- displays the system clock.

Eco power mode

- displays the system clock and switches to the standby mode.

20 DIM

- selects different levels of brightness for the display screen.

21 SUBTITLE

- selects a subtitle language.

22 ANGLE

- selects a DVD camera angle.

23 DISPLAY

- displays information on TV screen during playback

24 AUDIO

for VCD/DivX

- sets Stereo, Mono-Left or Mono-Right sound mode.

for DVD

- selects an audio language.

25 A-B

- repeats playback of a specific section on a disc.

26 MODE

- selects various repeat modes or the shuffle play mode for a disc.

27 SLOW

- selects different slow playback modes for a DivX/VCD/SVCD/DVD.

28 BASS +/-

- to adjust the bass boost level.

29 TREBLE +/-

- to adjust the treble (high tone) level.

30 LOUDNESS

- enables or disables automatic loudness adjustment.

Notes for remote control:

- **First, select the source you wish to control by pressing one of the source select keys on the remote control (DISC or TUNER, for example).**
- **Then select the desired function (▶||, ◀, ▶| for example).**

Getting Started

Step 1: Inserting batteries into the Remote Control

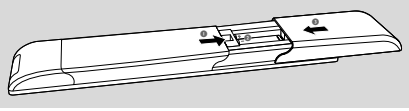

- 1 Open the battery compartment.
- 2 Insert two AAA batteries following the indications (+/-) inside the compartment.
- 3 Close the cover.

Using the Remote Control to operate the Player

- 1 Aim the Remote Control directly at the remote sensor (IR) on the front panel.
- 2 Do not put any objects between the Remote Control and the DVD Player while operating the DVD Player.

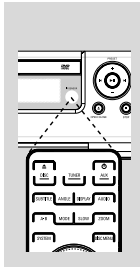

CAUTION!

- Remove batteries if they are exhausted or if the Remote Control is not being used for a long time.
- Do not use old and new or different types of batteries in combination.
- Batteries contain chemical substances, so they should be disposed of properly.

Step 2: Setting up the TV

IMPORTANT!

Make sure you have completed all the necessary connections. (See "Connecting TV").

- 1 Switch the DVD system on and then select DISC source. (See "Switching the system on/off").
- 2 Turn on the TV and set to the correct video-in channel. You should see the blue Philips DVD background screen on the TV.

- Usually these channels are between the lowest and highest channels and may be called FRONT, A/V IN, or VIDEO. See your TV manual for more details.
- Or, you may go to channel 1 on your TV, then press the Channel down button repeatedly until you see the Video In channel.
- Or, the TV Remote Control may have a button or switch that chooses different video modes.
- Or, set the TV to channel 3 or 4 if you are using an RF modulator:

Selecting the colour system that corresponds to your TV

This DVD Player is compatible with both NTSC and PAL. In order for a DVD disc to play on this Player; the colour system of the Disc, the TV and the DVD Player should match.

- 1 Press **SYSTEM** in full stop mode.
- 2 Press ◀ ▶ to select "PREFERENCE PAGE".
- 3 Use ◀ ▶ ▲ ▼ on the remote to navigate in the menu.

Move to "TV TYPE" and press ▶.

- **PAL**: Select this if the connected TV is PAL system. It will change the video signal of a NTSC disc and output in PAL format.
- **Auto**: Select this if the connected TV is compatible with both NTSC and PAL (multi-system). The output format will be in accordance with the video signal of the disc.
- **NTSC**: Select this if the connected TV is NTSC system. It will change the video signal of a PAL disc and output in NTSC format.

- 4 Select an item and press **OK**.

Notes:

- This option is available only when the "HDMI" is set to "OFF".
- Before changing the current TV Type setting, ensure that your TV supports the selected TV Type.



Setting up Progressive Scan feature (for Progressive Scan TV only)

The progressive scan display twice the number of frames per seconds than interlaced scanning (ordinary normal TV system). With nearly double the number of lines, progressive scan offers higher picture resolution and quality.

IMPORTANT!

Before enabling the progressive scan feature, you must ensure:

- 1) Your TV can accept progressive signals, a progressive scan TV is required.
- 2) You have connected the DVD player to your TV using Y Pb Pr (see "Connections-Step 5: Connecting TV- Using Component Video jacks".)

- 1 Turn on your TV.
- 2 Turn off your TV progressive scan mode or turn on interlaced mode (refer to your TV user manual).
- 3 Press **ECO POWER/STANDBY-ON**  (on the remote) to turn on the DVD player.
- 4 Select the correct Video Input channel.
→ The DVD background screen appears on the TV.
- 5 Press **SYSTEM**.
- 6 Press   repeatedly to select "VIDEO SETUP PAGE".
- 7 Select "TV MODE" to "P-SCAN", then **OK** to confirm.
→ The instruction menu appears on the TV.

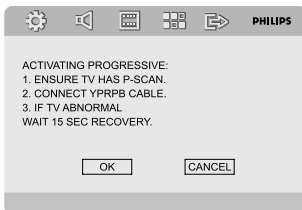

- 8 Press   to highlight "OK" in the menu and press **OK** to confirm.

There will be a distorted picture on your TV at this state until you turn on the progressive scan mode on your TV.

- 9 Turn on your TV progressive scan mode (refer to your TV user manual).
→ The below menu appears on the TV.

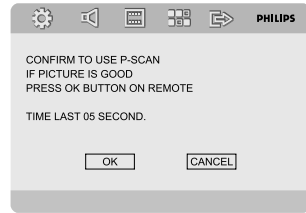

- 10 Press   to highlight "OK" in the menu and press **OK** to confirm.
→ The setup is complete now and you can start enjoy the high quality picture.

To deactivate Progressive manually

- **When the distorted sign still appears on the TV**, it may be due to the connected TV does not accept progressive signals, and progressive is set by mistake. You must reset the unit to interlace format.
- 1 Turn off your TV progressive scan mode or turn on to interlaced mode (refer to your TV user manual).
 - 2 Press **SYSTEM** on the remote to exit the system menu and then **DISC** and "1" to exit progressive scan.
→ The DVD blue background screen will appear on the TV.

Note:

- During normal playback in the progressive scan mode, pressing **DISC** button and "1" will exit the progressive scan mode.

Getting Started

Step 3: Setting language preference

You can select your own preferred language settings. This DVD system will automatically switch to the selected language whenever you load a disc. If the language selected is not available on the disc, the disc's default language will be used instead. The OSD language in the system menu will remain once selected.

Setting the OSD Language

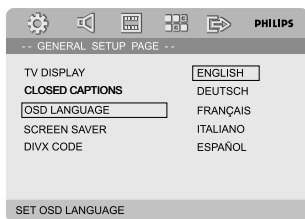

- 1 Press **SYSTEM**.
- 2 Press ◀▶ to select "GENERAL SETUP PAGE".
- 3 Use ◀▶ ▲ ▼ on the remote to navigate in the menu.
Move to "OSD LANGUAGE" and press ▶.
- 4 Select a language and press **OK**.

To exit from the menu

- Press **SYSTEM** again.

Setting the Audio, Subtitle and Disc Menu language

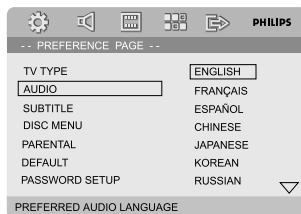

- 1 Press **SYSTEM** in stop mode.
- 2 Press ◀▶ to select "PREFERENCE PAGE".
- 3 Press ▲ ▼ to highlight the following in the Preference Page.
 - "AUDIO" (disc's soundtrack)
 - "SUBTITLE" (disc's subtitles)
 - "DISC MENU" (disc's menu)
- 4 Enter its submenu by pressing ▶.
- 5 Select a language and press **OK**.
- 6 Repeat steps 3~5 for other language settings.

To exit from the menu

- Press **SYSTEM** again.



Switching the system on/off

- Press **ECO POWER/STANDBY-ON**  (⏻) on the remote).
→ A countdown of 10 seconds starts for preheating of the system. Then, the system will switch to the last selected source.
- Press **DISC, TUNER** or **AUX** on the remote.
→ The system will switch to the selected source.

To switch the system to standby mode

- Press **ECO POWER/STANDBY-ON**  (⏻) on the remote).
→ "BYE BYE" is displayed briefly.

Switching the system to Eco Power Standby mode

- Press **ECO POWER/STANDBY-ON**  in active mode.
→ The system enters Eco power standby (the ECO POWER LED is on) or normal standby mode with clock display.
- The volume level (up to a maximum volume level of 12), interactive sound settings, last selected mode, source and tuner presets will be retained in the player's memory.
- If the system is in normal standby mode with clock display, press and hold **ECO POWER/STANDBY-ON**  for 3 seconds or more to switch to Eco power standby or vice versa.

Power-saving automatic standby

As a power-saving feature, the system will automatically switch to Standby mode if you do not press any buttons within 15 minutes after a disc has stopped playing.

Volume control

Turn **VOLUME (-/+)** clockwise or anticlockwise (or press **VOLUME +/-** on the remote) to increase or decrease the volume level.
→ "VOL XX" is displayed on the display panel. "XX" denotes the volume level.

To switch off the volume temporarily

- Press **MUTE** on the remote.
→ Playback will continue without sound and "MUTING" flashes.
- To activate sound reproduction, you can:
 - press **MUTE** again;
 - adjust the volume controls;
 - change source.

Sound control

BASS, TREBLE and LOUDNESS sound features cannot be activated at the same time.

Bass enhancement

Bass adjustment enhances the bass response.

- Press **BASS +/-** on the remote repeatedly to adjust the bass level.
→ Some discs might be recorded in high modulation, which causes a distortion at high volume. If this occurs, switch off DBB or reduce the volume.

Treble adjustment

The treble (high tone) setting enables you to adjust the treble level of the system.

- Press **TREBLE +/-** on the remote control repeatedly adjust the treble level.

LOUDNESS

LOUDNESS feature enables the system to automatically increase the treble and bass sound effect at low volume (the higher the volume, the lower the treble and bass increase).

- Press **LOUDNESS** on the remote to enable or disable LOUDNESS feature.
→  icon appears/disappears after this feature is enabled/disabled.

Dimming the display screen

- Press **DIM** repeatedly to select different levels of brightness for the display screen.

Demonstration mode

The system has a demonstration mode that shows the various features offered by the system.

To activate the demonstration

- In **standby mode**, press **STOP ■** on the system to activate the demo mode.
→ Demonstration will begin.

To deactivate the demonstration

- Press **STOP ■** on the system again.
→ "DEMO OFF" is displayed.

Note:

- *Even if you remove the AC power cord and reconnect it to the wall socket, the demonstration will remain off until you activate it again.*

IMPORTANT!

- Depending on the DVD or VIDEO CD, some operations may be different or restricted.
- Do not push on the disc tray or put any objects other than disc on the disc tray. Doing so may cause the disc player malfunction.
- If the inhibit icon (⊘) appears on the TV screen when a button is pressed, it means the function is not available on the current disc or at the current time.

Playable Discs

Your DVD Player will play:

- Digital Video Discs (DVDs)
- Video CDs (VCDs)
- Super-Video CDs (SVCDs)
- Digital Video Discs + Rewritable (DVD+RW)
- Compact Discs (CDs)
- Picture (Kodak, JPEG) files on CDR(W)
- DivX(R) disc on CD-R(W):
- DivX 3.11, 4.x and 5.x
- WMA
- Supported MP3-CD format.
- ISO 9660
- Max. title/album name –12 characters
- Max. title number plus album is 255.
- Max. nested directory is 8 levels.
- The max. album number is 32.
- The max. MP3 track number is 999.
- Supported sampling frequencies for MP3 disc: 32 kHz, 44.1 kHz, 48 kHz.
- Supported Bit-rates of MP3 disc are: 32, 64, 96, 128, 192, 256 (kbps).
- Following formats can't be supported
- The files like *.VMA, *.AAC, *.DLF, *.M3U, *.PLS, *.WAV
- Non-English Album/Title name
- The discs recorded under Joliet format
- MP3 Pro and MP3 with ID3 tag

Region Codes

DVDs must be labeled as shown below in order to play on this DVD system. You cannot play discs that are labeled for other regions.



Note:

- If you are having trouble playing a certain disc, remove the disc and try a different one. Improper formatted disc will not play on this DVD Player.

Playing discs

- 1 Connect the power cords of the system and TV (or any optional stereo or AV receiver) to a power outlet.
- 2 Turn on the TV power and set to the correct Video In channel. (See “**Setting up the TV**”).
- 3 Press **ECO POWER/STANDBY-ON** on the DVD Player front panel or on the remote.
 - You should see the blue Philips DVD background screen on the TV.
- 4 Press **OPEN•CLOSE** to open the disc tray and load in a disc, then press the same button again to close the disc tray.
 - Make sure the label side is facing up.
- 5 Playback will start automatically (depending on the disc type).
 - If a disc menu appears on the TV, see “**Using the Disc Menu**”.
 - If the disc is locked by parental control, you must enter your four-digit password. (See “**PASSWORD SETUP PAGE**”).
- 6 At any time, simply press **STOP** to stop playback.

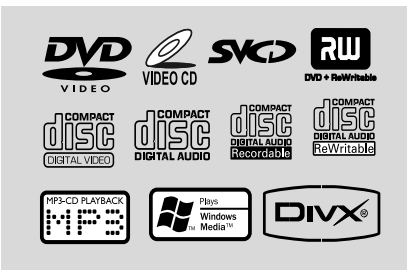

Using the Disc Menu

Depending on the disc, a menu may appear on the TV screen once you load the disc.

To select a playback feature or item

- Use **◀ ▶ ▲ ▼** and **OK** or **Numeric Keypad (0-9)** on the remote.
→ Playback will start automatically.

To access or exit from the menu

- Press **DISC MENU** on the remote.

For VCD with Playback Control (PBC) feature (version 2.0 only)

PBC playback allows you to play Video CDs interactively, following the menu on the display.

- During playback, press **DISC MENU**.
→ If PBC was ON, it will switch to OFF and continue playback.
→ If PBC was OFF, it will switch to ON and return to menu screen.

Basic playback controls

Pausing playback (DVD/VCD/CD/MP3/DivX/WMA)

- 1 During playback, press **▶II**.
→ Playback will pause and sound will be muted.
- 2 Press **▶II** again to resume.

Selecting a track/chapter/title (DVD/VCD/DivX/CD)

- 1 Press **▶I** during playback to go to the next chapter/track
- 2 Press **◀I** to go to the previous chapter/track.
- 3 To go directly to any chapter/track/title, enter the chapter/track/title number using the **Numeric Keypad (0-9)**.

Resuming playback from the last stopped point (DVD/VCD/CD)

- In stop mode and when a disc has not been removed, press **▶II**.

To cancel resume mode

- In stop mode, press **STOP ■** again.

Zoom (DVD/VCD/DivX/JPEG)

Zooming allows you to enlarge or reduce the video image during playback.

- 1 Press **ZOOM** repeatedly to enlarge or reduce the playback video image.
- 2 Press **◀ ▶ ▲ ▼** to pan across the TV screen.

Repeat (DVD/VCD/CD/MP3/DivX/WMA)

For DVD/VCD/CD

- Press **MODE** repeatedly to choose a repeat mode during playback.

Chapter (DVD)

- to repeat playback of the current chapter.

Track (CD/VCD)/Title (DVD)

- to repeat playback of the current track (CD/SVCD/VCD)/title (DVD).

All

- to repeat playback of all the disc.

Shuffle

- to repeat playback at random order.

For MP3/WMA/DivX

- Press **MODE** continuously to access different repeat modes.
→ **Shuffle**: play all files in the selected folder in random order.
→ **Repeat One**: play an MP3/WMA file repeatedly.
→ **Repeat All**: play all files repeatedly.
→ **Off**: switches off the shuffle or repeat mode.

Repeat A-B (DVD/VCD/CD/MP3/DivX/WMA)

- 1 Press **A-B** at your chosen starting point.
- 2 Press **A-B** again at your chosen end point.
→ The section A and B can be set only within the same chapter/track.
→ The section will now repeat continuously.
- 3 To exit the sequence, press **A-B** again.

Slow Motion (DVD/VCD)

- 1 Press **SLOW** during playback to select the required speed: 1/2, 1/4, 1/8 or 1/16 (backward or forward).
→ Sound will be muted.
- 2 To return to normal speed, press **▶||**

Note:

– *Slow backward is not possible on VCDs.*

Program (not for Picture CD)

To select favourite tracks/chapters for playback in preferred sequence.

For DVD/VCD/CD

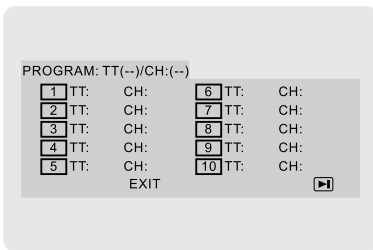

(DVD program for example)

- 1 Press **PROG** on the remote to enter the program mode.
- 2 Use the **Numerical Keypad (0-9)** to directly input the tracks or chapters (single track number with digit "0" in front, for example "05").
- 3 Move the cursor by pressing **◀ ▶ ▲ ▼** to select **START**.
- 4 Press **OK** to start playback.

For MP3/WMA

- 1 In Stop mode, press **DISC MENU** to switch the menu between Album and Filelist.
- 2 When Filelist is on the screen, press **▲ ▼** to select the files and press **PROG** to add the files to the program list.
- 3 Press **DISC MENU** to display the program list.
- 4 Press **PROG** to delete unwanted files from the program list.

Forward/Reverse Searching (DVD/VCD/DivX/CD/MP3/WMA)

- 1 Press **◀▶** on the remote during playback to select the required speed: 2X, 4X, 8X, 16X or 32X (backward or forward).
→ Sound will be muted.
- 2 To return to normal speed, press **▶||**

Time search & search by chapter/track number (DVD/VCD/CD/MP3/WMA)

- 1 Press **GOTO** until the time or chapter/track edit box appears.
- 2 Enter hours, minutes and seconds from left to right in the time edit box using remote control numerical keypad.

OR

Enter your desired chapter/track number in the chapter/track edit box using remote control numerical keypad.

Information display during playback (not for Picture CD)

- During playback, press **DISPLAY** to show disc information on the TV screen.

For DVD

- **Title/Chapter Elapsed:** displays the elapsed time of the current title/chapter.
- **Title/Chapter Remain:** displays the remaining time of the current title/chapter.
- **Display Off:** switches time display off.

Disc Operations

For SuperVCD/VCD/DivX/CD

- **Single/Total Elapsed**: displays the elapsed time of the current single/total track.
- **Single/Total Remain**: displays the remaining time of the current single/total track.
- **Display Off**: switches time display off.

Special disc features

Playing a Title (DVD)

- 1 Press **DISC MENU**.
→ The disc title menu appears on the TV screen.
- 2 Use **◀▶▲▼** or **Numeric Keypad (0-9)** to select a play option.
- 3 Press **OK** to confirm.

Camera Angle (DVD)

- Press **ANGLE** repeatedly to select different desired angle.

Changing the Audio Language (for DVD recorded with multiple languages)

- Press **AUDIO** repeatedly to select different audio languages.

Changing the Audio Channel (for VCD only)

- Press **AUDIO** to select the available audio channels provided by the disc (Mono Left, Mono Right or Stereo).

Subtitles (DVD)

- Press **SUBTITLE** repeatedly to select different subtitle languages.

Playing MP3/WMA/JPEG Picture CD

IMPORTANT!

You have to turn on your TV and set to the correct Video In channel. (See "Setting up the TV").

Playing MP3/WMA disc

IMPORTANT!

For DRM protected WMA files, use Windows Media Player 10 (or later) for CD burning/conversion. Visit www.microsoft.com for details about Windows Media Player and WM DRM (Windows Media Digital Rights Management).

General operation

- 1 Load an MP3/WMA disc.
→ The data disc menu appears on the TV screen.
- 2 Use **▲ ▼** to select an album and press **OK** to open the album.

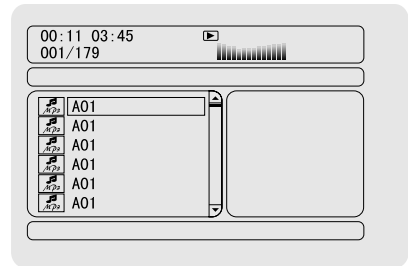

- 3 Press **▲ ▼** or use the **Numeric Keypad (0-9)** to highlight a track.
- 4 Press **OK** to confirm.
→ The playback will start from the selected track to the end of the album.

Note:

– The disc reading time may exceed 10 seconds due to large number of songs compiled onto the disc.

Playback selection

During playback, you can:

- Press **◀ / ▶** to select another track in the current album.
- Press **▶||** repeatedly to pause/resume playback.
- Press **DISC MENU** on the remote to switch between Album and Filelist.

Playing JPEG Picture CD

General operation

- 1 Load a JPEG Picture CD.
→ The data disc menu appears on the TV screen.
- 2 Use ▲ ▼ to select a folder and press **OK** to open the folder.
- 3 Press ▲ ▼ or use the **Numeric Keypad (0-9)** to highlight a picture file.
- 4 Press **OK** to confirm.
→ The playback will start from the selected picture to the end of the folder.

Playback selection

During playback, you can:

- Press ◀ / ▶ to select another file in the current folder.
- Use ◀ ▶ on the remote to rotate/flip the picture files.
- Press ▶ || repeatedly to pause/resume playback.
- Press **DISC MENU** on the remote to switch between Folder and Filelist.

Special JPEG features

Preview function (JPEG)

This function shows the content of the current folder or the whole disc.

- 1 Press **STOP** ■ during playback.
→ Thumbnails of 12 pictures appears on the TV screen.

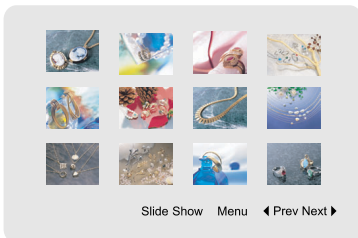

- 2 Use ◀ ▶ ▲ ▼ to highlight one of the pictures/ "Slide Show" and press **OK** to start playback/ slide show.

To enter the remote key function menu

- Use ◀ ▶ ▲ ▼ to highlight "Menu" and press **OK**.

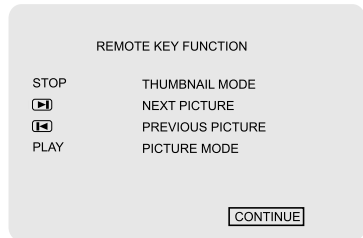

To display the other pictures on the previous/next page

- Press ◀ / ▶.
- Use ◀ ▶ ▲ ▼ to highlight "Prev" or "Next" and press **OK**.

Zoom picture (JPEG)

- During playback, press **ZOOM** repeatedly to display the picture with different scales.
- Use ◀ ▶ ▲ ▼ to view the zoomed picture.

Playback with multi-angles (JPEG)

- During playback, press ◀ ▶ to rotate the picture on the TV screen.
◀: rotate the picture anti-clockwise.
▶: rotate the picture clockwise.

Playing a DivX disc

This DVD player supports the DivX movie playback that you download from your computer onto a CD-R/RW (see "System Menu Options-DIVX(R) VOD registration code" for more information).

- ① Load a DivX disc.
→ Playback will start automatically. If not press **▶II**
- ② If the DivX movie contains external subtitles, the subtitle menu will appear on the TV screen for your selection.
- In this case, pressing **SUBTITLE** on the remote control will turn on or off the subtitle.
- If multilingual subtitles are embedded on the DivX disc, pressing **SUBTITLE** will change the subtitle language during playback.

Note:

- *Subtitle files with the following filename extensions (.srt, .smi, .sub, .ssa, .ass) are supported but do not appear on the file navigation menu.*
- *The subtitle filename have to be the same as the filename of the movie.*

Basic operations

- 1 Press **SYSTEM** to enter the Setup Menu.
- 2 Press ◀ ▶ to select a page to be set.
- 3 Press ▲ ▼ to highlight an option.
- 4 Enter its submenu by pressing ▶ or **OK**.
- 5 Move the cursor by pressing ▲ ▼ to highlight the selected item.
 - In cases of value setting, press ◀ ▶ to adjust values.
- 6 Press **OK** to confirm.

To return to the upper-level menu

- Press ◀ or **OK** (in cases of value adjustment).

To exit from the menu

- Press **SYSTEM** again.
 - The settings will be stored in the player's memory even if the player is switched off.

Note:

– Some of the features in the System Menu Options are described in "Getting Started".

GENERAL SETUP PAGE

The options included in GENERAL SETUP PAGE are: "TV DISPLAY", "OSD LANGUAGE", "CLOSED CAPTIONS", "SCREEN SAVER" and "DIVX CODE".

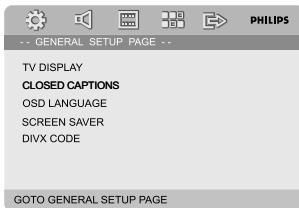

TV DISPLAY

Set the aspect ratio of the DVD Player according to the TV you have connected.

→ **NORMAL/PS**: If you have a normal TV and want both sides of the picture to be trimmed or formatted to fit your TV screen.



→ **4:3 NORMAL/LB**: If you have a normal TV. In this case, a wide picture with black bands on the upper and lower portions of the TV screen will be displayed.



→ **WIDE**: If you have a wide-screen TV.



OSD LANGUAGE

See "Getting Started-Step 3: Setting language preference".

CLOSED CAPTIONS

Closed captions are data that are hidden in the video signal of some discs. Captions are different from subtitles because captions hearing are impaired by showing the sound effects (e.g., "phone ringing" and "footsteps"), while subtitles do not.

Before you select this function, please ensure that the disc contains closed captions information and your TV set also has this function.

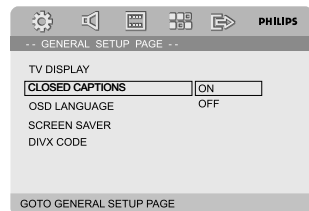

System Menu Options

- 1 Press **▲ ▼** to highlight 'CLOSED CAPTIONS'.
- 2 Enter its submenu by pressing **▶**.
- 3 Move the cursor by pressing **▲ ▼** to highlight the selected item.
→ **ON**: Enable Closed Captions.
→ **OFF**: Disable Closed Captions.

SCREEN SAVER

This function is used to turn the screen saver on or off.

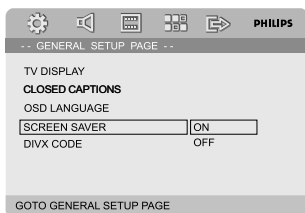

→ **ON**: In STOP, PAUSE or No DISC mode, if no actions are performed about 3 minutes, the screen saver will be activated.

→ **OFF**: Screen saver is disabled.

DIVX CODE

Philips provides you the DivX® VOD (Video On Demand) registration code that allows you to rent and purchase videos using the DivX® VOD service.

For more information, visit us at www.divx.com/vod.

- 1 In 'GENERAL SETUP PAGE', press **▲ ▼** to highlight DIVX Code, then press **▶** or **OK** to enter its submenu and press **OK** again to confirm.
→ The registration code will appear.

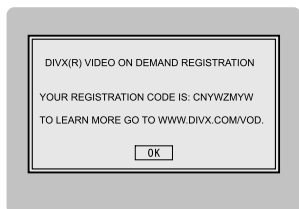

- 2 Press **OK** to exit.
- 3 Use the registration code to purchase or rent the videos from DivX® VOD service at www.divx.com/vod. Follow the instructions and download the video onto a CD-R for playback on this DVD player.

Notes:

- All the downloaded videos from DivX® VOD can only be played back on this DVD player.
- Time search feature is not available during DivX movie playback.

AUDIO SETUP PAGE

The options included in AUDIO SETUP PAGE are: "SPDIF SETUP", "DOLBY DIGITAL SETUP", "3D PROCESSING", "HDCCD" and "NIGHT MODE".

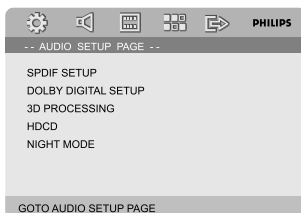

SPDIF SETUP

The options included in SPDIF SETUP page are: "SPDIF OFF", "SPDIF/RAW" and "SPDIF/PCM".

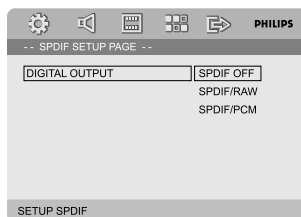

- **SPDIF OFF**: Turns off the SPDIF output.
- **SPDIF/RAW**: If you have connected your DIGITAL OUT (COAXIAL or OPTICAL) to a multi-channel decoder/receiver.
- **SPDIF/PCM**: Only if your receiver is not capable of decoding multi-channel audio.

DOLBY DIGITAL SETUP

The option included in DOLBY DIGITAL SETUP is: "DUAL MONO".

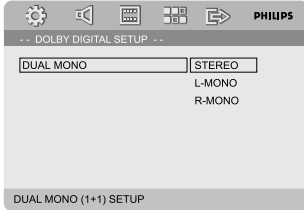

DUAL MONO

Select the setting that matches the number of speakers you have connected.

→ **STEREO**: Left mono sound will send output signals to Left speaker and Right mono sound will send output signals to Right speaker.

→ **L-MONO**: Left mono sound will send output signals to Left speaker and Right speaker.

→ **R-MONO**: Right mono sound will send output signals to Left speaker and Right speaker.

3D PROCESSING

The option included in 3D PROCESSING page is: "REVERB MODE".

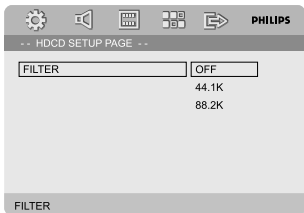

REVERB MODE

Reverb mode provides a virtual surround sound experience using just two speakers.

→ **OFF, CONCERT, LIVING ROOM, HALL, BATHROOM, CAVE, ARENA** and **CHURCH**.

HDCD

The option included in HDCD (High Definition Compatible Digital) is: "FILTER".

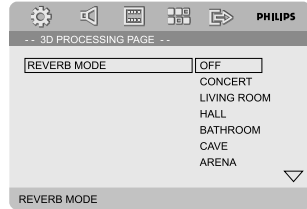

FILTER

Sets the audio output cutoff frequency point when playing an HDCD disc.

→ **OFF, 44.1K** and **88.2K**.

NIGHT MODE

In this mode, the high volume outputs are softened and low volume outputs are brought upward to an audible level. It is useful for watching your favourite action movie without disturbing others at night.

→ **ON**: Select this to level out the volume. This feature is only available for movies with Dolby Digital mode.

→ **OFF**: Select this when you want to enjoy the surround sound with its full dynamic range.

VIDEO SETUP PAGE

The options included in VIDEO SETUP PAGE are: "COMPONENT", "TV MODE", "QUALITY" and "HDMI SETUP".

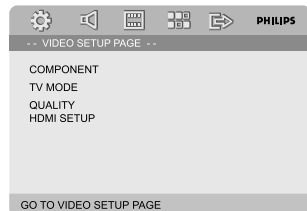

System Menu Options

COMPONENT

Sets the video output according to your video connection. This setting is not required if you are using the **VIDEO** jack (yellow) to connect the DVD micro system to your TV.

→ **S-VIDEO**: Select this if you have connected the DVD micro system to your TV using S-Video jack.

→ **Pr/Cr Pb/CbY**: Select this if you have connected the DVD micro system to your TV using Component video jacks.

NoteS:

- When the player is set to Y Pb Pr (YUV), some TV may not properly synchronise with the player on the SCART connector.
- This option is available only when the "HDMI" is set to "OFF".

TV MODE

Selects interlace or P-SCAN video output mode when **Pr/Cr Pb/CbY** is selected.

→ **P-SCAN** and **INTERLACE**.

In the progressive scan mode, you can enjoy the high quality picture with less flickers. It only works when you have connected the DVD player's Y Pb Pr jacks to your TV that supports the progressive video input. Otherwise, a distorted picture will appear on the TV. For proper progressive scan set up, see "Getting started-Setting up Progressive Scan feature".

Note:

- This option is available only when the "HDMI" is set to "OFF".

QUALITY

This menu helps you to set the video quality.

- 1 Press **▲▼** to highlight "QUALITY".
- 2 Press **▶** or **OK** to enter Quality Setup.

The options included in Quality Setup page are: "SHARPNESS", "BRIGHTNESS", "CONTRAST", "GAMMA", "HUE", "SATURATION" and "LUMA DELAY".

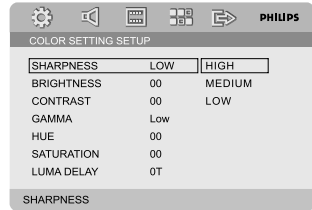

SHARPNESS

Adjusts the sharpness level.

→ **HIGH, MEDIUM** and **LOW**.

BRIGHTNESS

Adjusts the brightness level. Range: -20-+20.

CONTRAST

Adjusts the contrast level. Range: -16-+16.

GAMMA

Adjusts the gamma level.

→ **HIGH, MEDIUM, LOW** and **NONE**.

HUE

Adjusts the hue level. Range: -9-+9.

SATURATION

Adjusts the saturation level. Range: -9-+9.

LUMA DELAY

Adjusts the luma delay.

→ **0T** and **1T**.

HDMI SETUP

The options included in HDMI SETUP Page are: "HDMI" and "RESOLUTION".

HDMI

This option is used to enable/disable HDMI output.

- **ON:** Enables HDMI output.
- **OFF:** Disables HDMI output.

RESOLUTION

You can select the resolution of the picture according to your preference and the connected HDMI TV.

The resolution options include 480p (60Hz), 720p (60Hz), 1080i (60Hz), 576p (50Hz), 720p (50Hz) and 1080i (50Hz).

Notes:

- This option is available only when the "HDMI" is set to "ON".
- If no display appears on the TV screen due to unsupported resolution, reconnect any available interlace video output to your display and re-adjust the resolution settings to 480p/576p.

PREFERENCE PAGE

The options included in Preference page are: "TV TYPE", "AUDIO", "SUBTITLE", "DISC MENU", "PARENTAL" and "DEFAULT".

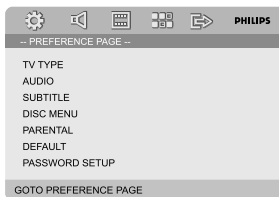

Note:

- Preference features can be selected only when no disc is in the player or when playback has stopped completely.

PARENTAL

Some DVDs may have a parental level assigned to the complete disc or to certain scenes on the disc. This feature lets you set a playback limitation level.

The rating levels are from 1 to 8 and are country dependent. You can prohibit the playing of certain discs that are not suitable for your children or have certain discs played with alternative scenes.

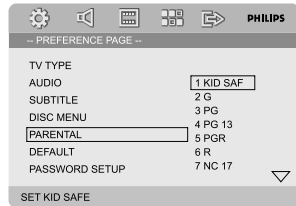

- VCD, SVCD and CD have no level indication, so parental control function has no effect on those kinds of discs. This applies to most illegal DVD discs.

- 1 Press ▲ ▼ to highlight "PARENTAL".
- 2 Enter its submenu by pressing ►.
- 3 Use ▲ ▼ to highlight a rating level for the disc inserted.
→ DVDs that are rated above the level you selected will not play unless you enter your four-digit password and choose a higher level rating.

Note:

- Some DVDs are not encoded with a rating though the movie rating may be printed on the Disc cover. The rating level feature does not work for such Discs.

Rating explanations

- 1 KID SAF
 - Kids material; recommended especially for children and viewers of all ages.
- 2 G
 - General Audience; recommended as acceptable for viewers of all ages.

System Menu Options

3 PG

- Parental Guidance suggested.

4 PG 13

- Material is unsuitable for children under age 13.

5-6 PGR, R

- Parental Guidance - Restricted; recommended that parents restrict children under 17 from viewing or allow to view only when supervised by a parent or adult guardian.

7 NC-17

- No children under age 17; not recommended viewing for children under age 17.

8 Adult

- Mature materials; should be viewed only by adults due to graphic sexual material, violence or language.

DEFAULT

Setting the "DEFAULT" function will reset all options and your personal settings to the factory defaults and all your personal settings will be erased.

Caution!

- **When this function is activated, all settings will be reset to factory defaults.**

PASSWORD SETUP PAGE

The options included in Password Setup page are: "PASSWORD MODE" and "PASSWORD".

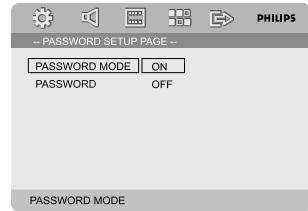

PASSWORD MODE

This feature is used to enable/disable password by selecting "ON"/"OFF".

PASSWORD

Enter your four digit password when a hint is displayed on the screen. The default password is 1234.

- 1 Press **▲▼** to highlight "PASSWORD".
- 2 Enter its submenu by pressing **▶**.
- 3 Press **OK** to open the page for inputting a new password.

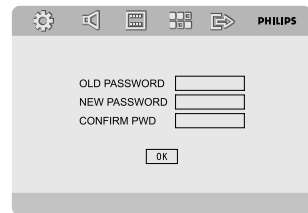

- 4 Enter the existing 4-digit code.
- 5 Enter the new 4-digit code.
- 6 Enter the new 4-digit code a second time to confirm.
→ The new 4-digit code will take effect.
- 7 Press **OK** to exit.

Notes:

- If the password has been changed, the parental and disc lock code will also be changed.
- The default password (1234) is always active even the password has been changed.

Radio Reception

Tuning to radio stations

- 1 Press **STANDBY-ON**  (⏻ on the remote) to switch on the last selected source.
- 2 Press **SOURCE (TUNER)** on the remote) to select TUNER mode.
- 3 Press **TUNER** on the remote again to select the desired band: FM or AM
- 4 Press and hold **◀ / ▶** (**◀◀ / ▶▶** on the remote) until the frequency indication starts to change, then release.
→ The system automatically tunes to the next strong radio station.
- To tune to a weak station, press **◀ / ▶** (**◀◀ / ▶▶** on the remote) briefly and repeatedly until an optimal reception is found.
- 5 Repeat Step 4 if necessary until you find the desired radio station.

Presetting radio stations

You can preset up to 40 stations (20 in each band) regardless of the reception.

Automatic programming

- Press **PROG** on the remote for more than two seconds to activate programming.
→ All available stations are programmed.

Manual programming

- 1 Tune to your desired radio station (refer to "Tuning to radio stations").
- 2 Press **PROG** on the remote.
→ "PROG" icon flashes.
- 3 Press **PRESET+/-** (or **◀ / ▶** on the remote) to select the desired preset number.
→ If "PROG" icon goes off before you select the desired preset number; press **PROG** on the remote.
- 4 Press **PROG** on the remote again to store the radio station.
- Repeat steps 1-4 to store other radio stations.

Listening to preset radio stations

- In tuner mode, press **PRESET+/-** (or **◀ / ▶** on the remote) to select the desired preset number.
→ The preset number; radio frequency, and waveband are displayed.

Other Functions

Setting the clock

- 1 In Standby mode, press and hold **CLOCK** on the remote until the time flashes on the display. → "CLOCK SET" is displayed briefly. Then, the hour digits flash on the display screen.
- 2 Turn **VOLUME +/-** clockwise or anticlockwise or press **VOLUME +/-** on the remote to set the hours.
- 3 Press **RDS/CLOCK** to confirm. → The minute digits flash on the display screen.
- 4 Turn **VOLUME +/-** clockwise or anticlockwise or press **VOLUME +/-** on the remote to set the minutes.
- 5 Press **RDS/CLOCK** again to confirm the clock setting.

Notes:

- This system only supports 12-hour mode.
- The clock setting will be erased when the system is disconnected from the power supply.
- The system will exit clock setting mode if no button is pressed within 30 seconds.

Setting sleep/wake-up timer

Sleep timer setting

In power-on mode, the sleep setting enables the system to switch to standby mode automatically at a preset time.

- 1 In power-on mode, press **SLEEP/TIMER** on the remote repeatedly to select a preset time. → The selections are as follows (time in minutes):
00 → 10 → 20 → 30 → 40 → 50 → 60 → 70 → 80 → 90 → 00
- 2 When you reach the desired length of time, stop pressing **SLEEP/TIMER**. → **z** appears.

To deactivate the sleep timer

- Press **SLEEP/TIMER** repeatedly until "00" is displayed, or press **ECO POWER/STANDBY-ON** (⏻ on the remote).

In standby mode, the timer setting enables the system to switch on automatically at a set time.

Wake-up timer setting

IMPORTANT!

– Before setting the timer, ensure that the clock is set correctly.

- 1 Press and hold **SLEEP/TIMER** until the time flashes on the display. → "TIMER SET" scrolls. Then, the hour digits flash on the display screen.
- 2 Turn **VOLUME +/-** clockwise or anticlockwise or press **VOLUME +/-** on the remote to set the hours.
- 3 Press **SLEEP/TIMER** to confirm. → The minute digits flash on the display screen.
- 4 Turn **VOLUME +/-** clockwise or anticlockwise or press **VOLUME +/-** on the remote to set the minutes.
- 5 Press **SLEEP/TIMER** to confirm the time setting. → "OFF" flashes on the display screen.
- 6 Turn **VOLUME +/-** clockwise or anticlockwise or press **VOLUME +/-** on the remote to select "ON". → **⏻** icon appears on the display screen.

To deactivate the timer

- Select "OFF" at Step 6.

SYSTEM

Power supply	120 V / 60 Hz
Rated working power consumption (1/8 rated output power)	≤ 85W
AUX input sensitivity	≤ 500mV
Channel Separation	≥ 40dB
Distortion	0.7%
Eco power Standby.....	< 1W

DVD

Frequency response	100Hz-20kHz (+0.5/-2 dB)
Video output	1 V _{P,P}
HDMI 480p (60Hz), 720p (60Hz), 1080i (60Hz), 576p (50Hz), 720p (50Hz), 1080i (50Hz)	
Horizontal definition	500 (TV)
Dimensions....	250 (W) × 90 (H) × 180 (D) mm
Weight	2.3 kg

AMPLIFIER

Rated output power (THD = 10%)	2x75W (4Ω)
Frequency response	100Hz-20kHz (+0.5/-2 dB)
S/N Ratio	≥ 60dB
Loaded impedance	4 Ω
Dimensions....	250 (W) × 90 (H) × 180 (D) mm
Weight	4.35 kg

TUNER

FM Frequency range	87.5-108 MHz
FM Noise limit sensitivity	≤ 20μV/M
FM S/N	≥ 46dB
AM wave range	520 – 1710 kHz
AM Noise limit sensitivity.....	≤ 3.0mV/m
AM S/N	≥ 40dB

SPEAKER

Impedance	4 Ω
Input power.....	75W
Sensitivity	80 ± 4dB
Frequency response	80Hz-16kHz
Dimensions .	205 (W) × 329 (H) × 240 (D) mm
Weight	6.82 kg each

REMOTE

Distance	6m
Angle	± 30°



Specifications subject to change without prior notice

Troubleshooting

WARNING

Under no circumstances should you try to repair the system yourself, as this will invalidate the warranty. Do not open the system as there is a risk of electric shock.

If a fault occurs, first check the points listed below before taking the system for repair. If you are unable to remedy a problem by following these hints, consult your dealer or Philips for help.

Problem	Solution
No power.	<ul style="list-style-type: none">✓ Check if the AC power cord is properly connected.✓ Press ECO POWER/STANDBY-ON  on the top of the DVD micro system or  on the remote to turn on the power.
No picture.	<ul style="list-style-type: none">✓ Check if the TV is switched on.✓ Check the video connection.✓ Press SOURCE on the top of the DVD player repeatedly to select "DVD" or press DISC on the remote.✓ Set your TV to the correct Video In channel. This channel is usually near channel 00. Or, you may have a button on the TV remote control that selects Auxiliary or A/V IN channel. See your TV owner's manual for details. Or, change channels at the TV until you see DVD screen on the TV.✓ If the progressive scan feature is activated but the connected TV does not support progressive signals or the cables are not connected accordingly, see "Getting started-Setting up Progressive Scan feature" for proper progressive scan setup or deactivate the progressive scan feature as below:<ol style="list-style-type: none">1) Turn off your TV progressive scan mode or turn on to interlaced mode.2) Press SYSTEM on the remote to exit the system menu and then DISC and "1" to exit progressive scan.
Distorted or poor picture.	<ul style="list-style-type: none">✓ Sometimes a small amount of picture distortion may appear. This is not a malfunction.✓ Clean the disc.
Completely distorted picture or black/white picture.	<ul style="list-style-type: none">✓ TV has a colour system standard. If the disc's or DVD system's colour system is different than your TV's colour system, the picture may be distorted or colourless.

The aspect ratio of the screen cannot be changed even though you have set the TV shape.

No sound or distorted sound.

The micro DVD player does not start playback.

The DVD micro system does not respond when the buttons are pressed.

Cannot activate some features, such as Angles, Subtitles, or multi-language Audio.

Considerable noise in radio broadcasts.

- ✓ The aspect ratio is fixed on the DVD disc.
- ✓ Depending on the TV, it may not be possible to change the aspect ratio.
- ✓ Adjust the volume.
- ✓ Check that the speakers are connected correctly.
- ✓ Replace the speaker cables.
- ✓ Disconnect the headphones.
- ✓ The system is in pause, slow motion or fast forward/reverse mode, press ► || to resume normal play mode.
- ✓ Insert a readable disc with the playback side facing down.
- ✓ Check the disc type, colour system and regional code. Check for any scratches or smudges on the disc.
- ✓ Press SYSTEM MENU to turn off the setup menu screen.
- ✓ Cancel the parental control rating function or change the rating level.
- ✓ Moisture has condensed inside the system. Remove the disc and leave the system turned on for about an hour.
- ✓ Disconnect the power plug from the outlet and insert again.
- ✓ Multi-language sound or subtitle is not recorded on the DVD.
- ✓ Changing the language for the sound or subtitle is prohibited on the DVD.
- ✓ The features may not be available on the disc.
- ✓ Tune in to the correct frequency.
- ✓ Connect the antennas.
- ✓ Fully extend the FM wire antenna. Position for best reception and secure to a wall.
- ✓ Connect an outdoor FM or AM antenna.
- ✓ Adjust the direction and position for best reception.
- ✓ Place the antenna farther away from any equipment that may be causing the noise.
- ✓ Increase the distance between the system and your TV or other equipment.

Troubleshooting

The remote control does not function.

- ✓ Select the correct source (DISC or TUNER, for example) before pressing the function button.
- ✓ Point the remote control at the remote sensor of the unit.
- ✓ Reduce the distance to the player.
- ✓ Remove any possible obstacles.
- ✓ Replace the batteries with new ones.
- ✓ Check that the batteries are loaded correctly.

The display is dark.

- ✓ Press DIM again.

Low hum or buzz sound.

- ✓ Place the DVD micro system as far away as possible from electrical devices that may be causing interference.

Low bass response.

- ✓ Check all speakers for correct polarity.

Unable to select Progressive Scan.

- ✓ Check that the output of the video signal is switched to 'Pr/Cr Pb/CbY'.

No sound is output from the HDMI jack.

- ✓ Check the connection between the TV and the HDMI jack of the DVD player.
- ✓ See if the TV supports this 480p/576p/720p/1080i DVD player.
- ✓ Check your TV system setup correctly.

Analog: Sound that has not been turned into numbers. Analog sound varies, while digital sound has specific numerical values. These jacks send audio through two channels, the left and right.

Aspect ratio: The ratio of vertical and horizontal sizes of a displayed image. The horizontal vs. vertical ratio of conventional TVs is 4:3, and that of wide-screens is 16:9.

AUDIO OUT Jacks: Jacks on the back of the DVD System that send audio to another system (TV set, Stereo, etc.).

Bit Rate: The amount of data used to hold a given length of music; measured in kilobits per second, or kbps. Or, the speed at which you record. Generally, the higher the bit rate the better the sound quality. However, higher bit rates use more space on a Disc.

Chapter: Sections of a picture or a music piece on a DVD that are smaller than titles. A title is composed of several chapters. Each chapter is assigned a chapter number enabling you to locate the chapter you want.

Component Video Out Jacks: Jacks on the back of the DVD System that send high-quality video to a TV set that has Component Video In jacks (R/G/B, Y/Pb/Pr, etc.).

Disc menu: A screen display prepared for the selection of images, sound, subtitles, multi-angles, etc recorded on a DVD.

Digital: Sound that has been converted into numerical values. Digital sound is available when you use the DIGITAL AUDIO OUT COAXIAL or OPTICAL jacks. These jacks send audio through multiple channels, instead of just two channels as analog does.

Dolby Digital: A surround sound system developed by Dolby Laboratories containing up to six channels of digital audio (front left and right, surround left and right and center).

JPEG: A still-picture data compression system proposed by the Joint Photographic Expert Group, which features small decrease in image quality in spite of its high compression ratio.

MP3: A file format with a sound data compression system, "MPE" is the abbreviation of Motion Picture Experts Group 1 (or MPEG-1) Audio Layer 3. Through the MP3 format, one CD-R or CD-RW can contain about 10 times as much data volume as a regular CD can.

Multichannel: DVD is specified to have all sound tracks constitute one sound field. Multichannel refers to a structure of sound tracks having three or more channels.

Parental control: A function of the DVD to limit playback of the disc by the age of the users according to the limitation level in each country. The limitation varies from disc to disc; when it is activated, playback will be prohibited if the software's level is higher than the user-set level.

PCM (Pulse Code Modulation): A system for converting analog sound signal to digital signal for later processing without data compression.

Playback control (PBC): Refers to the signal recorded on video CDs or SVCDs for reproduction control. By using screen menus recorded on a Video CD or SVCD that supports PBC, you can enjoy interactive-type software as well as software having a search function.

Progressive Scan (P-Scan): It displays all the horizontal lines of a picture at one time, as a signal frame. This system can convert interlaced video from DVD into progressive format for connection to a progressive display. It dramatically increases the vertical resolution. A progressive scan TV set is needed to receive progressive scan output from the system.

Region code: A system allowing discs to be played only in preset regions. This unit will only play discs that have compatible region codes. You can find the region code of your unit from the product label. Some discs are compatible with more than one region (or ALL regions).

S-Video: Produces a clear picture by sending separate signals for luminance and the color. You can use S-Video only if your TV set has S-Video In jack.

Sampling Frequency: Frequency of data sampling when analog data is converted to digital data. Sampling frequency numerically represents how many times the original analog signal is sampled per second.

Surround: A system for users to create realistic three-dimensional sound fields full of realism by arranging multiple speakers around the listener.

Title: The longest section of a picture or music feature on DVD, music, etc., in video software, or the entire album in audio software. Each title is assigned a title number enabling you to locate the title you want.

VIDEO OUT jack: Jack on the back of the DVD System that sends video to TV.

HDMI: High Definition Multimedia Interface. A specification developed by the HDMI Working Group that combines multi-channel audio and high definition video and that controls signals into a single digital interface for use with DVD players, digital television, and other audiovisual devices.

PHILIPS LIMITED WARRANTY ONE (1) YEAR

WARRANTY COVERAGE:

PHILIPS warranty obligation is limited to the terms set forth below.

WHO IS COVERED:

Philips warrants the product to the original purchaser or the person receiving the product as a gift against defects in materials and workmanship as based on the date of original purchase ("Warranty Period") from an Authorized Dealer. The original sales receipt showing the product name and the purchase date from an authorized retailer is considered such proof.

WHAT IS COVERED:

The Philips warranty covers new products if a defect arises and a valid claim is received by Philips within the Warranty Period. At its option, Philips will either (1) repair the product at no charge, using new or refurbished replacement parts, or (2) exchange the product with a product that is new or which has been manufactured from new, or serviceable used parts and is at least functionally equivalent or most comparable to the original product in Philips current inventory, or (3) refund the original purchase price of the product.

Philips warrants replacement products or parts provided under this warranty against defects in materials and workmanship from the date of the replacement or repair for ninety (90) days or for the remaining portion of the original product's warranty, whichever provides longer coverage for you. When a product or part is exchanged, any replacement item becomes your property and the replaced item becomes Philips' property. When a refund is given, your product becomes Philips' property.

Note: Any product sold and identified as refurbished or renewed carries a ninety (90) day limited warranty.

Replacement product can only be sent if all warranty requirements are met. Failure to follow all requirements can result in delay.

WHAT IS NOT COVERED - EXCLUSIONS AND LIMITATIONS:

This Limited Warranty applies only to the new products manufactured by or for Philips that can be identified by the trademark, trade name, or logo affixed to it. This Limited Warranty does not apply to any non-Philips hardware product or any software, even if packaged or sold with the product. Non-Philips manufacturers, suppliers, or publishers may provide a separate warranty for their own products packaged with the bundled product.

Philips is not liable for any damage to or loss of any programs, data, or other information stored on any media contained within the product, or any non-Philips product or part not covered by this warranty. Recovery or reinstallation of programs, data or other information is not covered under this Limited Warranty.

This warranty does not apply (a) to damage caused by accident, abuse, misuse, misapplication, or non-Philips product, (b) to damage caused by service performed by anyone other than Philips or Philips Authorized Service Location, (c) to a product or a part that has been modified without the written permission of Philips, or (d) if any Philips serial number has been removed or defaced, or (e) product, accessories or consumables sold "AS IS" without warranty of any kind by including refurbished Philips product sold "AS IS" by some retailers.

This Limited Warranty does not cover:

- Shipping charges to return defective product to Philips.
- Labor charges for installation or setup of the product, adjustment of customer controls on the product, and installation or repair of antenna systems outside of the product.
- Product repair and/or part replacement because of improper installation, connections to improper voltage supply, abuse, neglect, misuse, accident, unauthorized repair or other cause not within the control of Philips.
- Damage or claims for products not being available for use, or for lost data or lost software.
- Damage occurring to product during shipping.
- A product that requires modification or adaptation to enable it to operate in any country other than the country for which it was designed, manufactured, approved and/or authorized, or repair of products damaged by these modifications.
- A product used for commercial or institutional purposes (including but not limited to rental purposes).
- Product lost in shipment and no signature verification receipt can be provided.
- Failure to operate per Owner's Manual.

TO OBTAIN ASSISTANCE IN THE U.S.A., PUERTO RICO, OR U.S. VIRGIN ISLANDS...

Contact Philips Customer Care Center at:
1-888-PHILIPS (1-888-744-5477)

TO OBTAIN ASSISTANCE IN CANADA...

1-800-661-6162 (French Speaking)
1-888-PHILIPS (1-888-744-5477) - (English or Spanish Speaking)

REPAIR OR REPLACEMENT AS PROVIDED UNDER THIS WARRANTY IS THE EXCLUSIVE REMEDY FOR THE CONSUMER. PHILIPS SHALL NOT BE LIABLE FOR ANY INCIDENTAL OR CONSEQUENTIAL DAMAGES FOR BREACH OF ANY EXPRESS OR IMPLIED WARRANTY ON THIS PRODUCT. EXCEPT TO THE EXTENT PROHIBITED BY APPLICABLE LAW, ANY IMPLIED WARRANTY OF MERCHANTABILITY OR FITNESS FOR A PARTICULAR PURPOSE ON THIS PRODUCT IS LIMITED IN DURATION TO THE DURATION OF THIS WARRANTY.

Some states do not allow the exclusions or limitation of incidental or consequential damages, or allow limitations on how long an implied warranty lasts, so the above limitations or exclusions may not apply to you.

This warranty gives you specific legal rights. You may have other rights which vary from state/province to state/province.

Philips, P.O. Box 671539, Marietta, GA. 30006-0026

3121 233 48801

PHILIPS CONSUMER ELECTRONICS NORTH AMERICA

P.O. Box 671539, Marietta, GA. 30006-0026

Meet Philips at the Internet

<http://www.philips.com>

<http://www.philips.com/support>

English

Français

Español

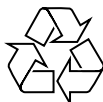

MCD908



© Royal Philips Electronics N.V. 2007
All rights reserved.

Printed in China

PDCC-JS_JW-0704